

# GP2S22

## Subminiature Photointerrupter

### ■ Features

1.  $\phi$  4mm compact resin mold type
2. Focal distance: 0.6mm
3. Visible light cut-off type

### ■ Applications

1. Audio equipment
2. VCRs

### ■ Outline Dimensions

(Unit : mm)

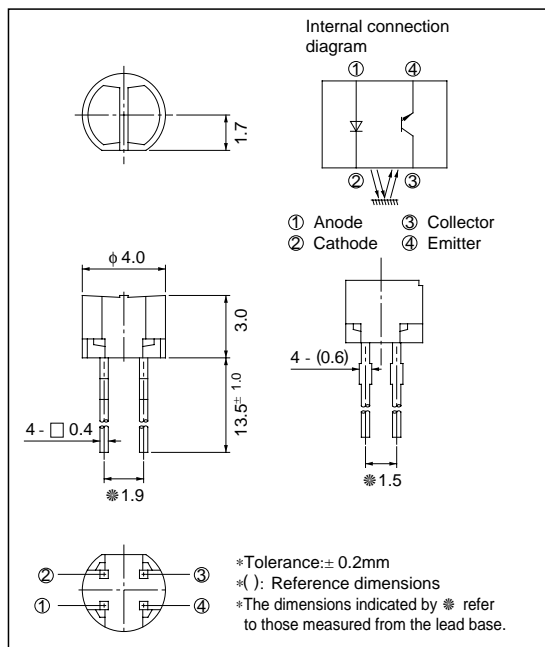

### ■ Absolute Maximum Ratings

(Ta = 25°C)

Parameter		Symbol	Rating	Unit
Input	Forward current	$I_F$	50	mA
	Reverse voltage	$V_R$	6	V
	Power dissipation	P	75	mW
Output	Collector-emitter voltage	$V_{CEO}$	35	V
	Emitter-collector voltage	$V_{ECO}$	6	V
	Collector current	$I_C$	20	mA
	Collector power dissipation	$P_C$	75	mW
Total power dissipation		$P_{tot}$	100	mW
Operating temperature		$T_{opr}$	- 25 to + 85	°C
Storage temperature		$T_{sg}$	- 40 to + 100	°C
*1 Soldering temperature		$T_{sol}$	260	°C

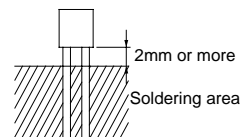

\*1 For 3 seconds by manual soldering

**Electro-optical Characteristics**

( $T_a = 25^\circ\text{C}$ )

Parameter		Symbol	Conditions	MIN.	TYP.	MAX.	Unit	
Input	Forward voltage	$V_F$	$I_F = 20\text{mA}$	-	1.2	1.4	V	
	Reverse current	$I_R$	$V_R = 6\text{V}$	-	-	10	$\mu\text{A}$	
Output	Collector dark current	$I_{CEO}$	$V_{CE} = 20\text{V}, I_F = 0$	-	$10^{-9}$	$10^{-7}$	A	
Transfer characteristics	*2Collector current		$I_C$	$V_{CE} = 2\text{V}, I_F = 4\text{mA}$	20	-	125	$\mu\text{A}$
	Response time	Rise time	$t_r$	$V_{CE} = 2\text{V}, I_C = 100\mu\text{A}$ $R_L = 1\text{k}\Omega, d = 1\text{mm}$	-	20	100	$\mu\text{s}$
		Fall time	$t_f$		-	20	100	$\mu\text{s}$
	*3Leak current		$I_{LEAK}$	$V_{CE} = 2\text{V}, I_F = 4\text{mA}$	-	-	0.1	$\mu\text{A}$

\*2 The condition and arrangement of the reflective object are shown in the following drawing.

\*3 Without reflective object

The ranking of collector current shall be classified into the following 6 ranks.

Rank	$I_C (\mu\text{A})$
A	58 to 125
B	34 to 71
C	20 to 42
A or B	34 to 125
B or C	20 to 71
A, B or C	20 to 125

**Test Condition and Arrangement for Collector Current**

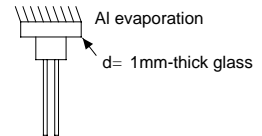

**Fig. 1 Forward Current vs. Ambient Temperature**

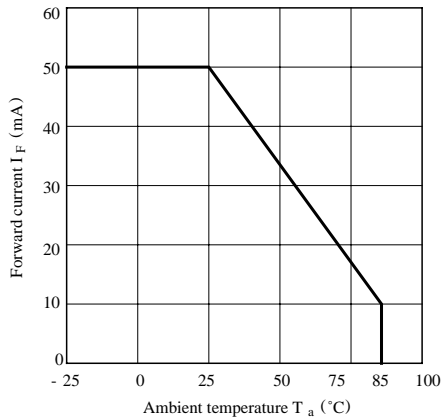

**Fig. 2 Power Dissipation vs. Ambient Temperature**

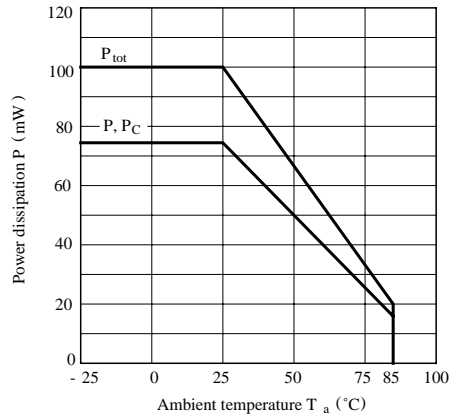

Fig.3 Forward Current vs. Forward Voltage

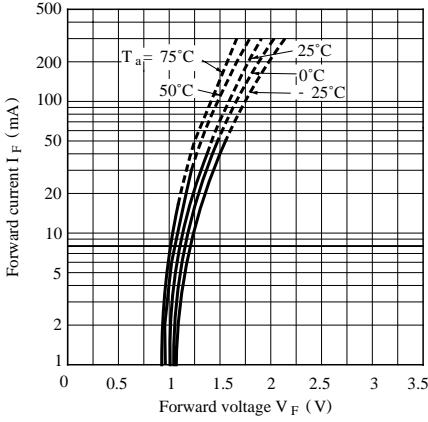

Fig.4 Collector Current vs. Forward Current

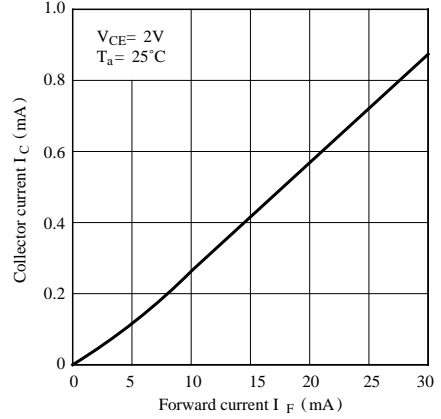

Fig. 5 Collector Current vs. Collector-emitter Voltage

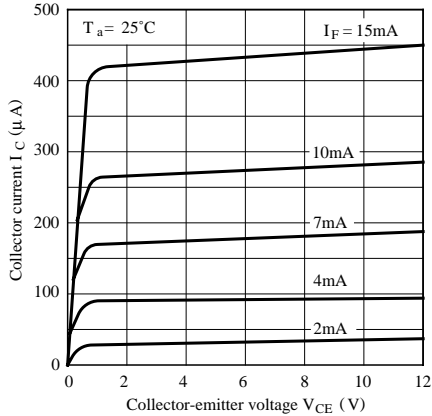

Fig. 6 Collector Current vs. Ambient Temperature

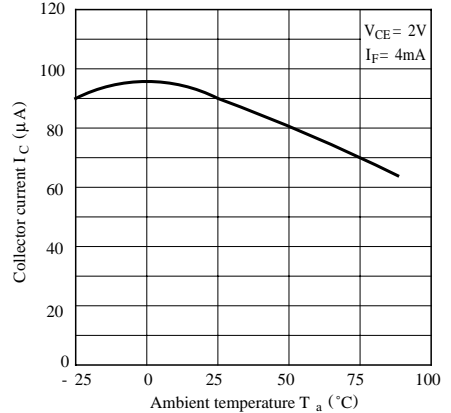

Fig. 7 Collector Dark Current vs. Ambient Temperature

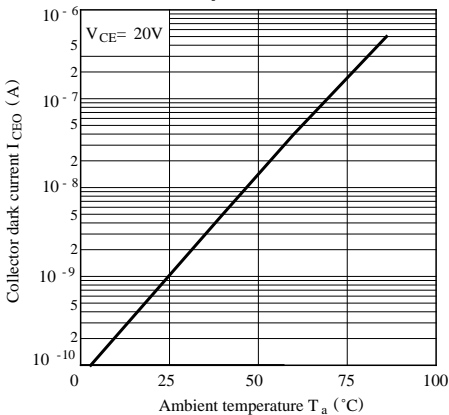
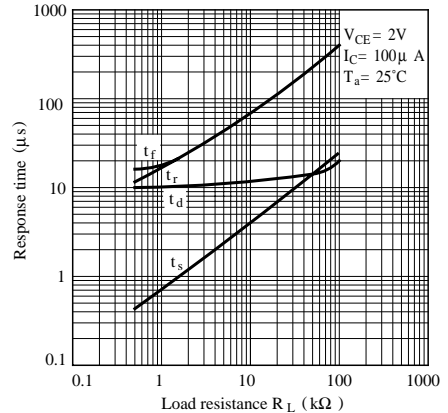

Fig. 8 Response Time vs. Load Resistance



Test Circuit for Response Time

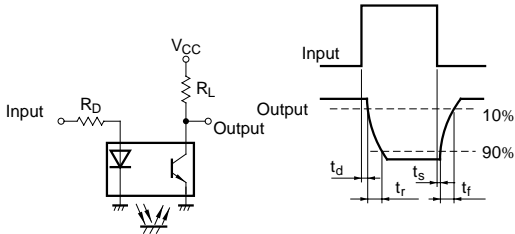
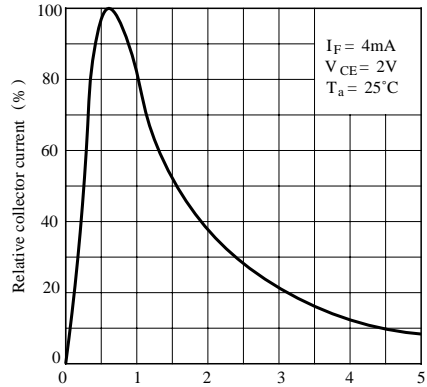
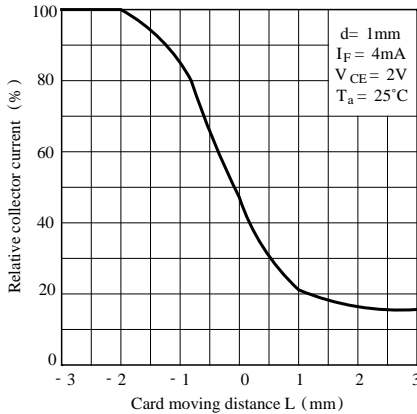

Fig. 9 Relative Collector Current vs. Distance between GP2S22 and Card



Distance between GP2S22 and test card d (mm)

Fig.10 Relative Collector Current vs. Card Moving Distance



Distance Characteristics Test Condition

Correspond to Fig.9

SHARP OMS TEST CARD (WHITE)



Correspond to Fig.10

SHARP OMS TEST CARD

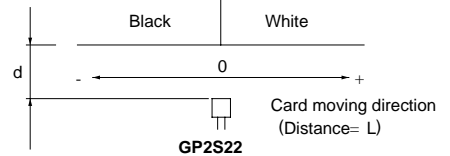

■ Precautions for Use

- (1) Perform soldering manually
- (2) Please refrain from soldering under preheating and refrain from soldering by reflow.
- (3) As for other general cautions, refer to the chapter “Precautions for Use”.